

Part 1

STEEL HINGES

- white zinc plated
- yellow zinc plated
- brass plated
- nickel plated
- bronze plated

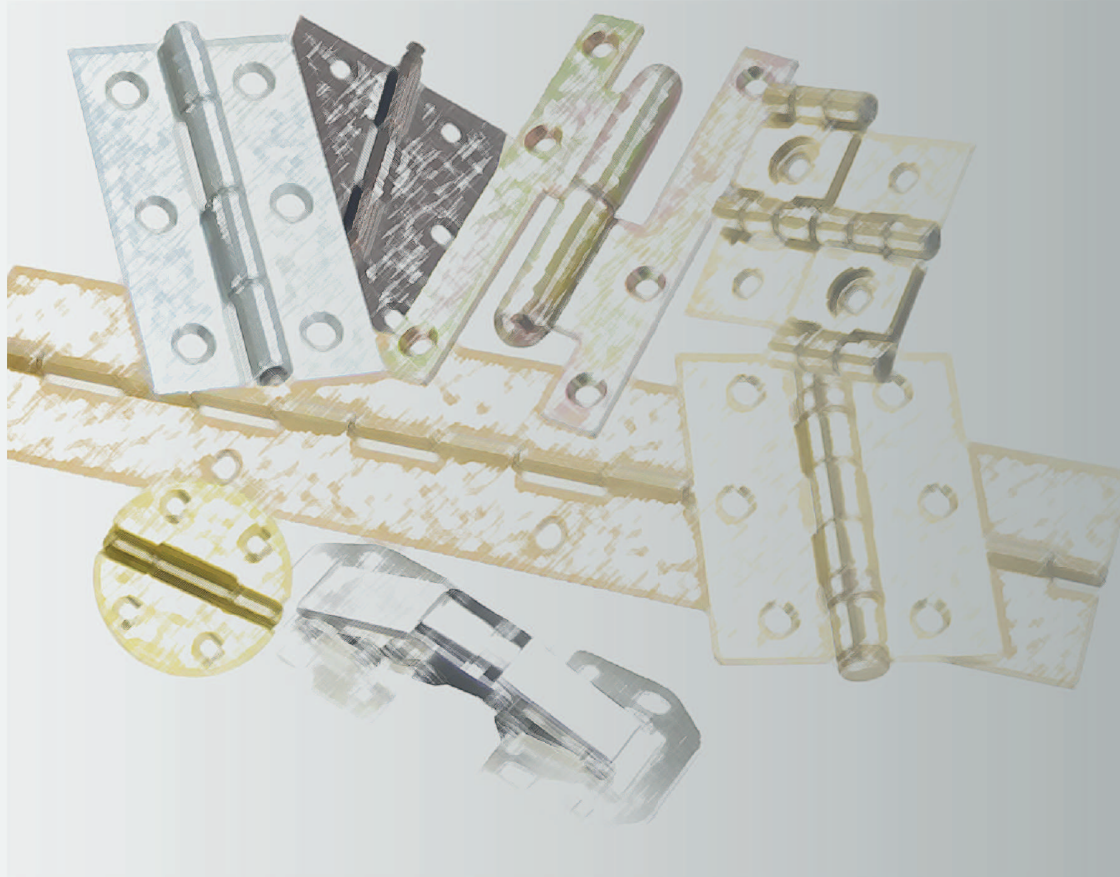

CERNIERIFICIO VALTOCE s.n.c.
di De Margaritis A. & W.

ART. 323

NARROW WHITE ZINC PLATED STEEL HINGES Fixed pin.

H x L x s (mm)	D	N
20 x 15 x 0,7	1,8	4
25 x 20 x 0,8	2,4	4
30 x 22 x 0,9	3,2	4
35 x 22 x 0,8	2,8	4
40 x 29 x 0,9	3,3	4
45 x 29 x 0,9	3,0	4
50 x 30 x 0,9	3,7	6
57 x 30 x 0,9	3,7	6
63 x 35 x 0,9	4,2	6
70 x 40 x 1,0	4,4	6
75 x 40 x 1,0	4,4	6
80 x 45 x 1,2	4,8	6
90 x 50 x 1,2	4,8	6
100 x 50 x 1,2	4,8	8
120 x 65 x 1,2	5,0	8

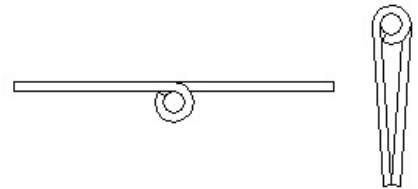
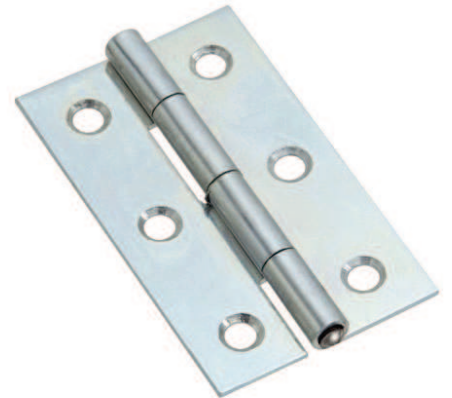

ART. 317

SQUARE WHITE ZINC PLATED STEEL HINGES Fixed pin.

H x L x s (mm)	D	N
20 x 20 x 0,7	2,4	4
25 x 25 x 0,8	2,8	4
30 x 30 x 0,9	3,2	4
35 x 35 x 0,8	3,4	4
40 x 40 x 0,9	4,1	4
45 x 45 x 0,9	3,6	6
50 x 50 x 0,9	4,2	6
57 x 57 x 0,9	4,4	6
63 x 63 x 0,9	4,4	6
70 x 70 x 1,0	4,4	6
75 x 75 x 1,0	4,4	6
80 x 80 x 1,2	4,8	6
90 x 90 x 1,2	4,4	8
100 x 100 x 1,2	4,8	8

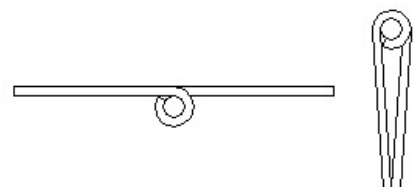

ART. 330

LONG WHITE ZINC PLATED STEEL HINGES

Fixed pin.

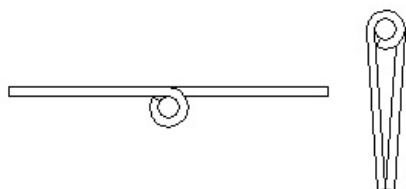
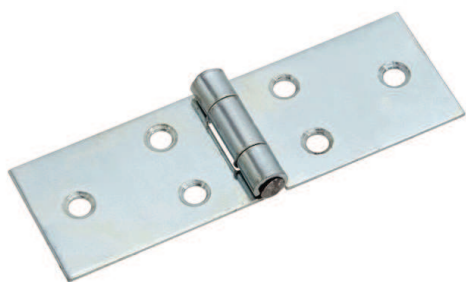

H x L x s (mm)	D	N
20 x 50 x 0,9	3,4	6
22 x 60 x 1,0	3,5	6
22 x 70 x 1,0	3,4	6
23 x 80 x 1,0	3,8	6
26 x 90 x 1,3	4,8	6
26 x 100 x 1,3	4,8	6
26 x 110 x 1,3	4,8	6
26 x 120 x 1,3	4,8	6
30 x 130 x 1,5	4,8	8
30 x 140 x 1,5	4,8	8
30 x 150 x 1,6	4,8	8
30 x 160 x 1,6	4,9	8
34 x 180 x 2,0	5,0	8
34 x 200 x 2,0	5,0	8

ART. 321

HALF SQUARE WHITE ZINC PLATED STEEL HINGES

Fixed pin.

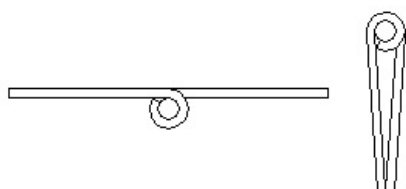

H x L x s (mm)	D	N
25 x 22 x 0,8	2,8	4
30 x 25 x 0,9	3,2	4
35 x 32 x 0,8	3,4	4
40 x 35 x 0,9	3,2	4
50 x 40 x 0,9	4,1	6
60 x 50 x 0,9	4,0	6
70 x 55 x 1,0	4,4	6
80 x 60 x 1,2	4,4	6



ART. 838

HEAVY DUTY WHITE ZINC PLATED STEEL HINGES Fixed pin.

H x L x s (mm)	D	N
40 x 35 x 1,2	4,2	4
45 x 35 x 1,2	4,2	4
50 x 40 x 1,3	4,3	6
57 x 40 x 1,3	4,3	6
63 x 45 x 1,3	4,5	6
70 x 50 x 1,3	4,8	6
75 x 50 x 1,3	4,9	6
86 x 55 x 1,5	5,0	6
100 x 70 x 1,6	5,5	8

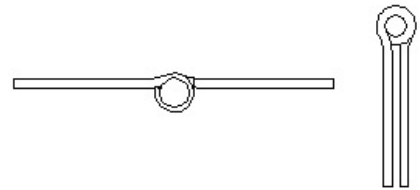

ART. 840

HEAVY DUTY WHITE ZINC PLATED STEEL HINGES Removable pin.

H x L x s (mm)	D	N
40 x 35 x 1,2	4,2	4
45 x 35 x 1,2	4,2	4
50 x 40 x 1,3	4,3	6
57 x 40 x 1,3	4,3	6
63 x 45 x 1,3	4,5	6
70 x 50 x 1,3	4,8	6
75 x 50 x 1,3	4,9	6
86 x 55 x 1,5	5,0	6
100 x 70 x 1,6	5,5	8
115 x 70 x 1,8	4.8	6

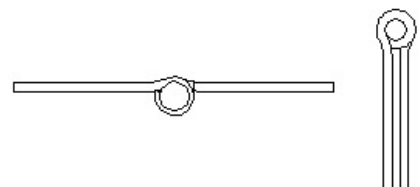

ART. 816

RECTANGULAR HEAVY DUTY WHITE ZINC PLATED STEEL HINGES
Fixed pin.

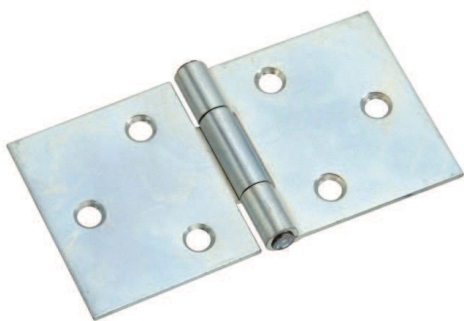

H x L x s (mm)	H (inches)	D x N
25 x 50 x 1,2	1"	4,1 x 6
31 x 60 x 1,5	1" 1/4	4,5 x 6
38 x 70 x 1,5	1" 1/2	5,0 x 6
42 x 80 x 1,5	1" 3/4	4,9 x 6
50 x 95 x 1,6	2"	5,4 x 6
64 x 110 x 2,0	2" 1/2	5,8 x 6
75 x 140 x 2,8	3"	6,9 x 8

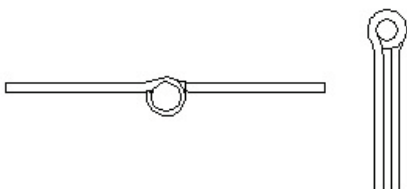

ART. 804

HEAVY DUTY WHITE ZINC PLATED STEEL HINGES
Removable pin.



H x L x s (mm)	H x L (inches)	D x N
50 x 50 x 1,6	2" x 2"	5,5 x 4
65 x 65 x 2,0	2" 1/2 x 2" 1/2	5,2 x 6
75 x 65 x 2,0	3" x 2" 1/2	5,2 x 6
75 x 75 x 2,0	3" x 3"	5,2 x 6
90 x 75 x 2,5	3" 1/2 x 3"	5,2 x 6
90 x 90 x 2,5	3" 1/2 x 3" 1/2	5,2 x 6
100 x 90 x 2,5	4" x 3" 1/2	5,2 x 8
100 x 100 x 2,5	4" x 4"	5,2 x 8
125 x 125 x 3,0	5" x 5"	5,2 x 8

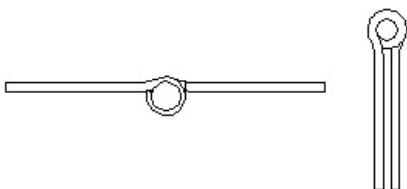

ART. 808

EXTRA HEAVY DUTY WHITE ZINC PLATED STEEL HINGES Fixed pin.

H x L x s (mm)	H x L (inches)	D x N
50 x 50 x 1,6	2" x 2"	5,5 x 4
65 x 65 x 2,0	2" 1/2 x 2" 1/2	5,2 x 6
75 x 65 x 2,0	3" x 2" 1/2	5,2 x 6
75 x 75 x 2,0	3" x 3"	5,2 x 6
90 x 75 x 2,5	3" 1/2 x 3"	5,2 x 6
90 x 90 x 2,5	3" 1/2 x 3" 1/2	5,2 x 6
100 x 90 x 2,5	4" x 3" 1/2	5,2 x 8
100 x 100 x 2,5	4" x 4"	5,2 x 8
115 x 115 x 2,5	4" 1/2 x 4" 1/2	6,2 x 8
125 x 125 x 3,0	5" x 5"	5,2 x 8

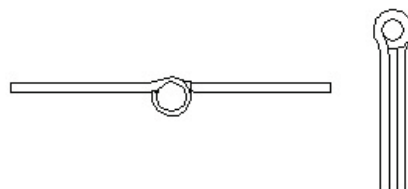

ART. 280

BLACK PAINTED OR YELLOW ZINC PLATED STEEL STRAP HINGES

H x L (mm)	s (mm)	D x N
30 x 120	2,0 + 2,0	5,5 x 4
30 x 140	2,0 + 2,0	5,5 x 4
30 x 160	2,0 + 2,0	5,5 x 4
30 x 180	2,0 + 2,0	5,5 x 4
30 x 200	2,0 + 2,0	5,5 x 6
30 x 220	2,0 + 2,0	5,5 x 6
30 x 240	2,0 + 2,0	5,5 x 6
38 x 260	2,0 + 2,0	5,5 x 6
38 x 280	2,0 + 2,0	5,5 x 6
38 x 300	2,0 + 2,0	5,5 x 6

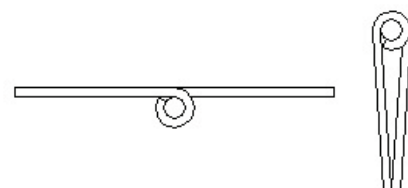

ART. 2805

BRASS OR BRONZE PLATED STEEL HINGES WITH BALL BEARINGS
Screws included. Ball tips. Removable pin.



H x L x s (mm)	H x L (inches)	D x N
75 x 65 x 2,0	3" x 2" 1/2	5,2 x 6
75 x 75 x 2,0	3" x 3"	5,2 x 6
90 x 75 x 2,5	3" 1/2 x 3"	5,2 x 6
100 x 75 x 3,0	4" x 3"	5,2 x 8
100 x 90 x 3,0	4" x 3" 1/2	5,2 x 8

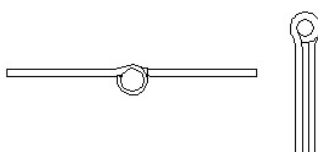

ART. 2806

BRASS, BRONZE OR SATIN CHROME PLATED STEEL HINGES WITH BALL BEARINGS
Screws included. Flat tips. Removable pin.



H x L x s (mm)	H x L (inches)	D x N
75 x 65 x 2,0	3" x 2" 1/2	5,2 x 6
75 x 75 x 2,0	3" x 3"	5,2 x 6
90 x 75 x 2,5	3" 1/2 x 3"	5,2 x 6
100 x 75 x 3,0	4" x 3"	5,2 x 8
100 x 90 x 3,0	4" x 3" 1/2	5,2 x 8

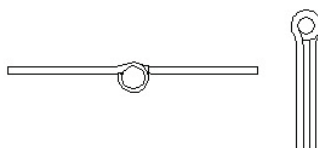

ART. 2706

BRASS OR BRONZE PLATED STEEL CRANKED HINGES WITH BALL BEARINGS
Screws included. Flat tips. Removable pin.



H x L x s (mm)	H x L (inches)	D x N
75 x 65 x 2,0	3" x 2" 1/2	5,2 x 6
90 x 75 x 2,5	3" 1/2 x 3"	5,2 x 6
100 x 90 x 3,0	4" x 3" 1/2	5,2 x 8



ART. 900

YELLOW ZINC PLATED STEEL LIFT-OFF HINGES

Right and left.

H x L x s (mm)	D	N
80 x 40 x 2,5	4,9	6
110 x 55 x 3,0	5,3	6
140 x 60 x 3,5	5,6	8

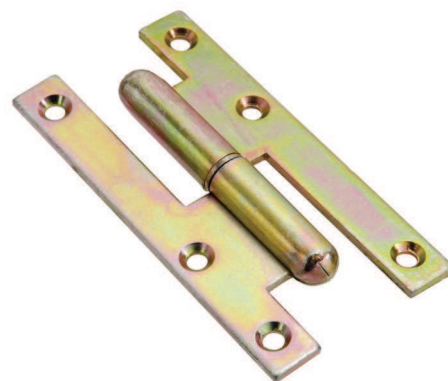

ART. 520

DOUBLE EFFECT SPRING ACTION HEAVY DUTY HINGES

Finishes: BRASS, BRONZE or NICKEL PLATED. Screws included

H (mm)	H (inches)
75	3
100	4
125	5
150	6
175	7

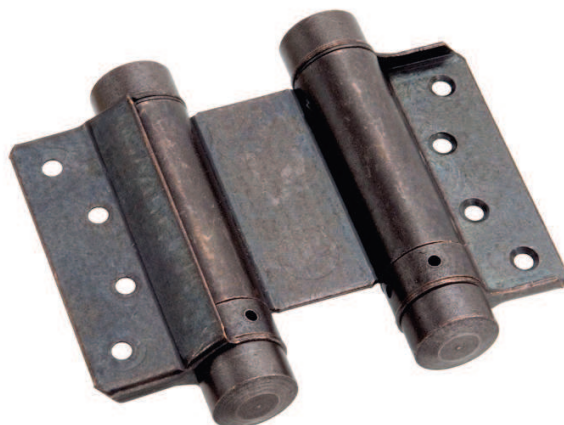

ART. 530

SINGLE EFFECT SPRING ACTION HEAVY DUTY HINGES

Finishes: BRASS, BRONZE or NICKEL PLATED. Screws included

H (mm)	H (inches)
75	3
100	4
125	5
150	6
175	7



ART. 500

DOUBLE EFFECT SPRING ACTION LIGHT DUTY HINGES
Finishes: BRASS or BRONZE PLATED. Screws included.

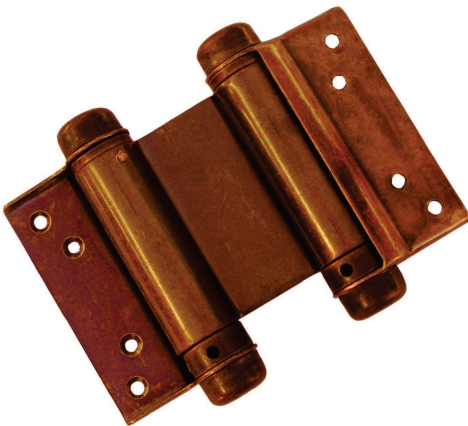

H (mm)	H (inches)
75	3
100	4
125	5

ART. 510

SINGLE EFFECT SPRING ACTION LIGHT DUTY HINGES
Finishes: BRASS or BRONZE PLATED. Screws included.



H (mm)	H (inches)
75	3
100	4
125	5

ART. 1838

BRASS OR BRONZE PLATED STEEL HEAVY HINGES "BAROQUE"
STYLE



H x L x s (mm)	D	N
40 x 35 x 1,2	4,2	4
50 x 40 x 1,3	4,3	6
63 x 45 x 1,3	4,5	6



ART. 1322

BRONZE PLATED STEEL HINGES "BAROQUE" STYLE

H x L x s (mm)	D	N
30 x 30 x 0,9	3,2	4
40 x 35 x 0,9	3,2	4
50 x 40 x 0,9	4,0	6
60 x 50 x 0,9	4,0	6
70 x 55 x 1,0	4,4	6

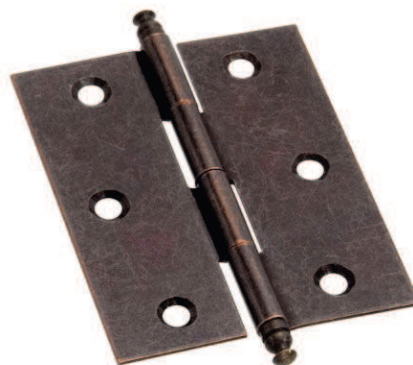

ART. 346

YELLOW ZINC PLATED STEEL LIFT-OFF HEAVY HINGES
Right and left.

H x L x s (mm)	D	N
50 x 40 x 1,3	4,0	4
63 x 50 x 1,3	5,0	6
75 x 60 x 1,3	5,5	6



ART. 347

YELLOW ZINC OR NICKEL PLATED STEEL LIFT-OFF HINGES
Right and left.

H x L x s (mm)	D	N
40 x 40 x 0,9	3,6	6
50 x 40 x 0,9	3,9	6
60 x 50 x 0,9	3,9	6
70 x 55 x 1,0	3,9	6



ART. 352

YELLOW ZINC OR NICKEL PLATED STEEL LIFT-OFF CRANKED HINGES

Right and left.



H x L x s (mm)	D	N
40 x 40 x 0,9	3,9	4
50 x 40 x 0,9	3,9	6
60 x 50 x 1,0	4,3	6

ART. 349

YELLOW ZINC OR NICKEL PLATED STEEL HINGES

Removable pin.

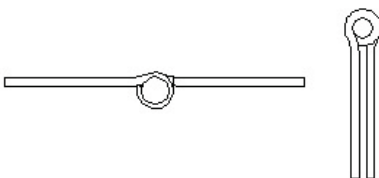

H x L x s (mm)	D	N
30 x 30 x 0,9	3,3	4
35 x 35 x 0,8	3,4	4
40 x 35 x 0,9	3,4	4
40 x 40 x 0,9	4,0	4
50 x 40 x 0,9	4,0	6
50 x 50 x 0,9	4,0	6
60 x 50 x 0,9	4,0	6
70 x 55 x 1,0	4,4	6
80 x 60 x 1,2	4,4	6

ART. 350

YELLOW ZINC OR NICKEL PLATED STEEL CRANKED HINGES

Removable pin. Right and left.



H x L x s (mm)	D	N
40 x 40 x 0,9	3,3	6
50 x 40 x 0,9	3,8	6
60 x 50 x 0,9	3,8	6
70 x 55 x 1,0	4,0	6



ART. 322

YELLOW ZINC OR NICKEL PLATED STEEL HINGES
Fixed pin.

H x L x s (mm)	D	N
30 x 30 x 0,9	3,3	4
35 x 35 x 0,8	3,4	4
40 x 35 x 0,9	3,4	4
50 x 40 x 0,9	4,0	6
60 x 50 x 0,9	4,0	6
70 x 55 x 1,0	4,4	6

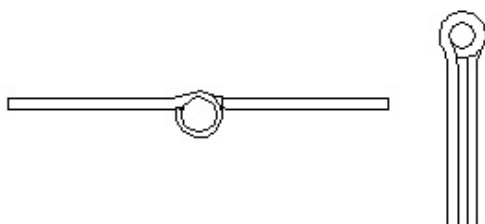

ART. 325

BRASS OR BRONZE PLATED BISCUIT SHAPED STEEL HINGES

H x L x s (mm)	D	N
32 x 80 x 1,5	5,0	6



ART. 326

WHITE OR YELLOW ZINC PLATED HEAVY BISCUIT SHAPED STEEL HINGES

H x L x s (mm)	D	N
30 x 80 x 2,0	5,0	6

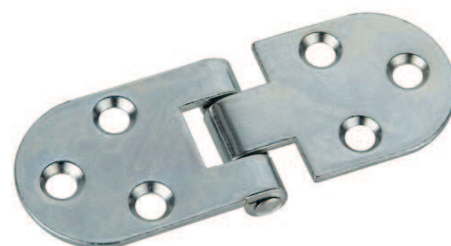

ART. 327

BRASS PLATED STEEL ROUND HINGES



H x L x s (mm)	D	N
40 x 40 x 1,3	3,5	4

ART. 342

BRASS PLATED STEEL HINGES FOR SCREENS

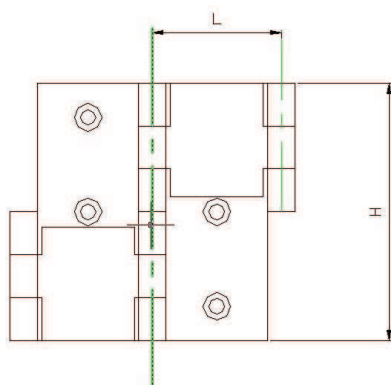

H x L (mm)	D x N
40 x 20 x 1,0	3,2 x 4
50 x 25 x 1,0	3,2 x 6
60 x 30 x 1,2	3,6 x 6
70 x 35 x 1,2	3,6 x 6

ART. 205

LIGHTWEIGHT BRASS PLATED STEEL HINGES



L x H x s (mm)	D	N
10 x 16 x 0,5	1,3	4
13 x 15 x 0,5	1,3	4
13 x 20 x 0,5	1,3	4
15 x 20 x 0,5	1,3	4
15 x 25 x 0,5	1,3	4
15 x 30 x 0,5	1,6	4
18 x 30 x 0,5	2,2	4
18 x 60 x 0,5	2,4	6
20 x 20 x 0,6	2,0	4
20 x 30 x 0,6	2,0	4



ART. 215

BRASS, BRONZE OR NICKEL PLATED STEEL PIANO HINGES
With holes.

H x L x s (mm)	D
1980 x 25 x 0,7	3,7
1980 x 32 x 0,7 (*)	3,7
1980 x 40 x 0,7	3,7

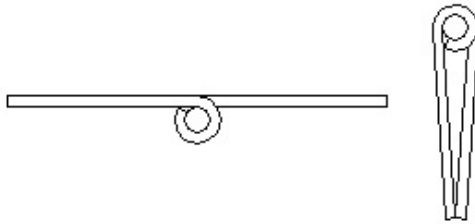

(*) Also available in plain steel without holes, 1980 mm long or in coils 50 metres long.

ART. 230

HEAVY DUTY STEEL PIANO HINGES
Without holes.

H x L x s (mm)	Pin size
1980 x 40 x 1,5	4,0
1980 x 50 x 1,5	4,0
1980 x 50 x 2,0	6,0
1980 x 60 x 2,0	6,0

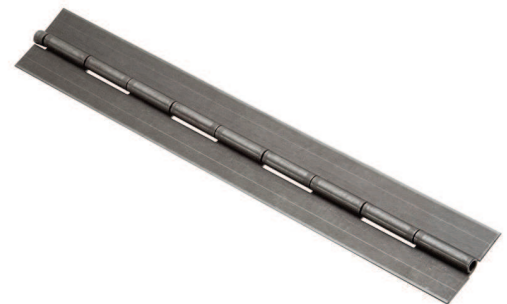

ART. 206

BLACK RUSTIC HINGES

H x L x s (mm)	D	N
23 x 39 x 0,7	3,0	4



ART. 207

BLACK RUSTIC HINGES



H x L x s (mm)	D	N
45 x 45 x 0,7	3,0	4

ART. 208

BLACK RUSTIC HINGES



H x L x s (mm)	D	N
45 x 45 x 0,7	3,0	2

Available also with eye.

ART. 285

BLACK RUSTIC HINGES FOR TRADITIONAL FURNITURE



H x L x s (mm)	D	N
70 x 40 x 1,6	3,4	6

ART. 290

BLACK RUSTIC HINGES FOR TRADITIONAL FURNITURE



H x L x s (mm)	D	N
70 x 110 x 1,6	3,4	3 + 2



ART. 295

BLACK RUSTIC CRANKED HINGES FOR TRADITIONAL FURNITURE

H x L x s (mm)	D	N
70 x 110 x 1,6	3,4	3 + 2



ART. 5500

BLACK PAINTED STEEL TRUNK HINGES WITH STAPLE

L (mm)
100
120



ART. 5600

NICKEL PLATED STEEL EASY-ON HINGES
With or without spring.

H x L (mm)	N
43 x 100	4 + 4

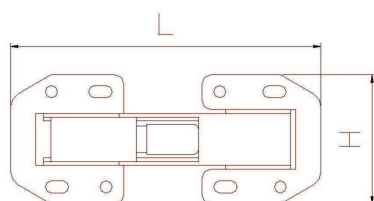

ART. 5200

NICKEL PLATED STEEL EASY-ON HINGES ON DIFFERENT LEVELS

H x L (mm)	N
48 x 115	3 + 3

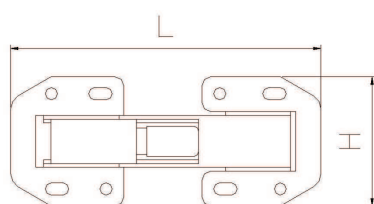

ART. 10

NARROW WHITE ZINC PLATED STEEL HINGES Fixed pin.

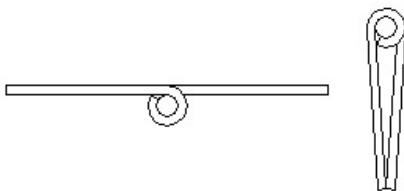

H x L x s (mm)	D	N
20 x 15 x 0,7	1,8	4
25 x 21 x 0,8	2,4	4
30 x 21 x 1,0	3,2	4
40 x 30 x 1,0	3,0	4
50 x 30 x 1,0	3,0	4
63 x 35 x 1,0	3,0	6
70 x 40 x 1,0	3,5	6
80 x 45 x 1,2	4,0	6
100 x 50 x 1,5	4,8	8
120 x 65 x 1,2	5,0	8

Stamped countersunk holes.

ART. 15

SQUARE WHITE ZINC PLATED STEEL HINGES Fixed pin.

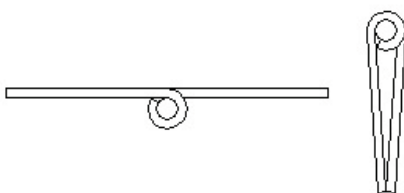

H x L x s (mm)	D	N
20 x 20 x 0,7	2,4	4
30 x 30 x 0,8	2,8	4
40 x 40 x 1,0	3,2	4
50 x 50 x 0,9	3,4	4
63 x 63 x 1,0	4,1	6
70 x 70 x 1,2	4,0	6
80 x 80 x 1,2	4,5	6
100 x 100 x 1,5	4,7	8

Stamped countersunk holes.



ART. 20

LONG WHITE ZINC PLATED STEEL HINGES

Fixed pin.

H x L x s (mm)	D	N
22 x 60 x 1,0	3,5	6
23 x 80 x 1,0	3,8	6
26 x 100 x 1,3	4,0	6
26 x 120 x 1,3	4,8	6
30 x 140 x 1,5	4,8	8
30 x 160 x 1,5	4,9	8
34 x 180 x 2,0	5,0	8
34 x 200 x 2,0	5,0	8

Stamped countersunk holes.

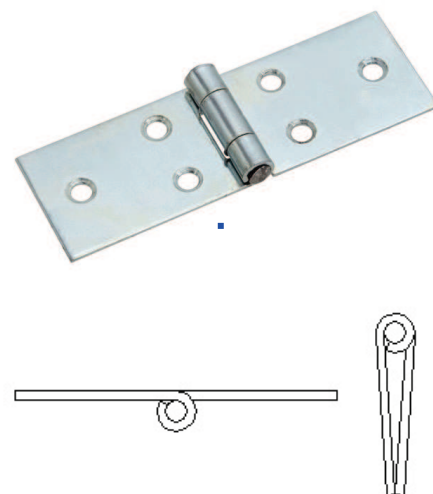

ART. 40

HEAVY WHITE ZINC PLATED STEEL HINGES

Removable pin.

H x L x s (mm)	D	N
40 x 35 x 1,3	4,8	4
50 x 38 x 1,5	4,8	4
63 x 40 x 1,5	4,8	6
75 x 50 x 2,0	5,0	6
85 x 60 x 2,0	6,0	8
100 x 75 x 2,0	6,0	8

Stamped countersunk holes.

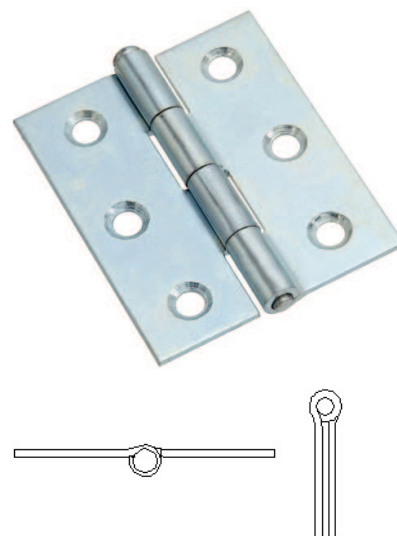

ART. 950

WHITE ZINC PLATED STEEL HINGES FOR WOODEN SIDES FOR PALLETS

H x s (mm)	D
180+30 x 1,2	5,5

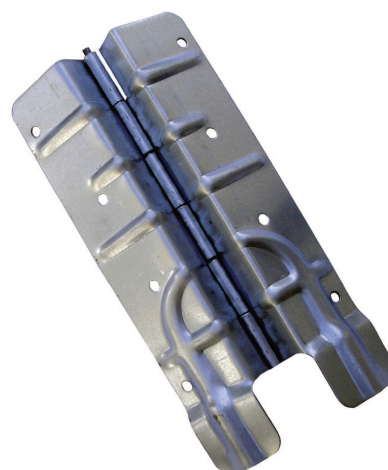

ART. 49

BRASS PLATED STEEL HINGES
Removable pin.



H x L x s (mm)	D	N
30 x 30 x 0,9	3,3	4
40 x 35 x 0,9	3,4	4
50 x 40 x 0,9	4,0	6
60 x 50 x 0,9	4,0	6
70 x 55 x 1,0	4,4	6
80 x 80 x 1,2	4,8	6

ART. 22

BRASS PLATED STEEL HINGES
Fixed pin.



H x L x s (mm)	D	N
30 x 30 x 0,9	3,3	4
40 x 35 x 0,9	3,4	4
50 x 40 x 0,9	4,0	6
60 x 50 x 0,9	4,0	6
70 x 55 x 1,0	4,4	6
75 x 50 x 1,6	4,9	6
80 x 80 x 1,2	4,8	6
100 x 70 x 1,8	5,5	8

ART. 340

WHITE ZINC PLATED DOVETAIL SHAPED STEEL
HINGES - fixed pin



H x L x s (mm)	D	N
40 x 90 x 2,0	5,0	6
50 x 110 x 2,0	5,0	8



ART. 1000

TWO WINGED WELD-ON STEEL HINGES
Removable pin.

D x H (mm)	s (mm)
10 x 60	2,0
12 x 80	2,0
13 x 100	2,0
14,6 x 120	2,3
16 x 140	2,5
17,4 x 140	2,7
17,4 x 170	2,7
20 x 200	3,0

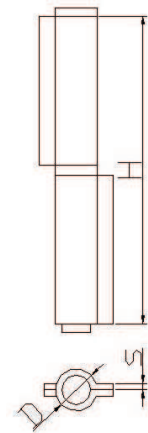

ART. 1050

THREE WINGED WELD-ON STEEL HINGES
Removable pin.

D x H (mm)	s (mm)
12 x 80	2,0
13 x 100	2,0
14,6 x 120	2,3
16 x 140	2,5
17,4 x 140	2,7
17,4 x 170	2,7
20 x 200	3,0

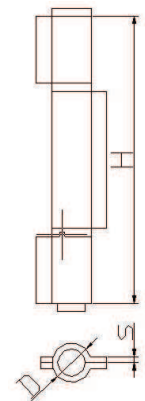

ART. 1100

TWO WINGED WELD-ON STEEL HINGES
Fixed pin.

D x H (mm)	s (mm)
10 x 60	2,0
12 x 80	2,0
13 x 100	2,0
14,6 x 120	2,3
16 x 140	2,5
17,4 x 140	2,7
17,4 x 170	2,7
20 x 200	3,0

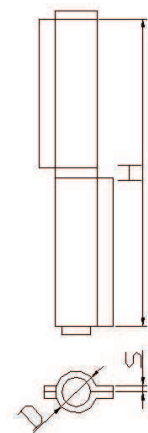

ART. 1200

WELD-ON STEEL HINGES
Removable pin.

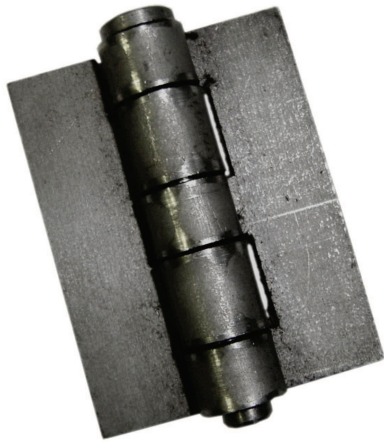

H x L (mm)	s (mm)
60 x 46	2,8
80 x 56	2,8
100 x 60	3,0
120 x 65	3,5

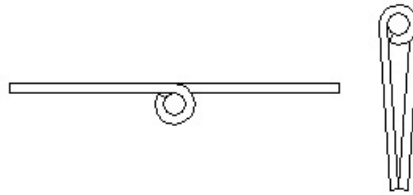

ART. 1400

LIFT-OFF WELD-ON STEEL HINGES
Removable pin, right and left.



H x L (mm)	s (mm)
60 x 28	2,5
80 x 28	2,7
100 x 40	3,0
120 x 40	3,0
140 x 45	3,5
160 x 45	3,5

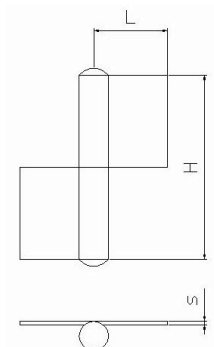

ART. 1550

TEARDROP PROFILE HINGES
Pin and ring in yellow zinc plated steel.



D x H (mm)	Pin size
10 x 40	6
10 x 60	6
12 x 80	7
14 x 100	8
16 x 120	9
16 x 140	9
18 x 140	10
20 x 140 (*)	12
22 x 150 (*)	14

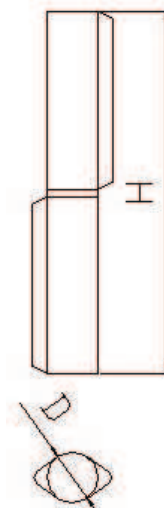

(*) With removable brass washer.



ART. 1560

TEARDROP PROFILE HINGES
Pin and ring in brass.

D x H (mm)	Pin size
10 x 40	6
10 x 60	6
12 x 80	7
14 x 100	8
16 x 120	9
16 x 140	9
18 x 140	10
20 x 140	12
22 x 150	14

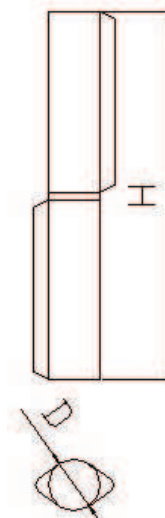

ART. 1570

TEARDROP PROFILE HINGES
Pin and ball bearing in yellow zinc plated steel.

D x H (mm)	Pin size
18 x 140	10
20 x 140	12
22 x 150	14

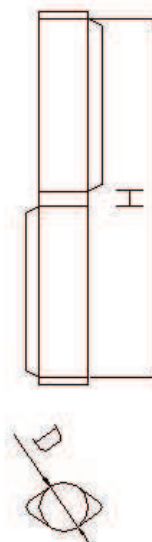

ART. 1580

TEARDROP PROFILE HINGES
With ball bearing. Pin in brass.

D x H (mm)	Pin size
18 x 140	10
20 x 140	12
22 x 150	14

